

WR PLUMB BOB NEWS

2008-03
Feb. 18, 2008



Information for plumb bob collectors

Edited by Wolfgang Ruecker Germany

plumbbobwolf@t-online.de

Plumb Bob “Caps” and “Tips”

The terms, “cap” and “tip”, when used to talk about plumb bobs, may be used in the broad sense to refer to the top and bottom of any bob but more specifically to denote separate pieces, if the bob happens to be constructed with multiple parts.

The “cap” of the bob, is always the top of the bob (in its working position) , and is always associated with the attachment of the string, rope, chain, or wire, all of which form the “plumb line.” It is at that point of attachment (where the flexible plumb line meets the rigid bob) that plumb bobs of all shapes, symmetrical or non symmetrical, come to rest with their center of gravity directly beneath the plumb line.

The “tip” of a bob has come to mean the “bottom” of the bob. Although the word “tip” is synonymous with the word “point”, in the case of plumb bobs it is common practice to think of the “tip” as meaning the bottom even if the bob is not formed to a precise point.

However, many bobs are formed with their bottoms intentionally forming a very precise point. This allows the plumb line to serve two different purposes:

1. As an offset measuring reference and
2. To indicate a point or to point to an imaginary point on a surface that is directly beneath the plumb line.

The most precise tools are symmetrically constructed so that the plumb line connection to the “cap”, the center of gravity of the body of the plumb bob, and a very pointed “tip”, are precisely aligned.

The most technically advanced offset reading and “pointing“ bobs are those that are intentionally constructed with all those features in mind.

There is a general point in time, I would speculate in the early nineteenth century, perhaps before, where in Europe and the United States, we see plumb bob technology focused on the precision and protection of the tip and then on very intentional symmetry of the plumb bob body. (Perfection)

Bruce Cynar, coined the term “Transitional“, to describe the earliest examples of bobs that have highly pointed tips, that are either reversible, or have their sharp tip protected with a tip cover. (Hamburg city gate)

In the case of bobs that come more or less to a point, the “tip” of the bob may be cast as the lowest part of the body, ergo, both “parts” are the same material. There are rare and interesting examples of one piece bobs that have their tips tempered or hardened to protect them from damage.

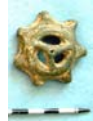

WR PLUMB BOB NEWS

2008-03
Feb. 18, 2008



Information for plumb bob collectors

Edited by Wolfgang Ruecker Germany

plumbbobwolf@t-online.de

Technically improved bobs would employ a harder material for the tip than for the body. In the Western World the most common material combination is brass used for the body and steel for the point. Brass is soft and characteristically easy to mold into the shape of the body, whereas steel can be formed to a precise point and due to its hardness withstand a higher degree of use and abuse. Although body materials may vary greatly, steel for tips is the material of preference.

This distinction in the characteristics of materials leads technologically into multi piece bobs where different materials are joined together by a variety of methods. Tips and caps appear as fixed in place parts, removable parts, invertable parts, and then, as spring protected tips and intentionally replaceable parts. Simultaneously, some level of mass production came into play in the manufacture of this tool. It is distinction in joinery of caps and tips to the plumb bob body that needs definition.

Additionally, there are references to pointed plumb bobs that are designed to be “dropped” so that the “tip” serves the added function of being a marking device, (VAJENS) or to mark the location of the tip with chalk. (BULLET)

The parts of a plumb bob

CAP

BODY

TIP



Bobs that clearly do not come to a point, may be tear drop, ovate or flat bottom in shape, or of the primitive sort, may be totally asymmetrical (a rock tied to a string). Bobs without points can only be used as an OFFSET MEASURING TOOL; the bob has no “pointing” capability. Different professions find each type (pointed or blunt) useful in their distinct trades. Generally speaking, a woodworker would want benefit from a pointing device; whereas a mason would find a flat bottom bob his tool of preference to build up plumb walls.

Thus, pointed bobs have caps, bodies and tips; Un-pointed bobs have only caps and bodies or just bodies alone.

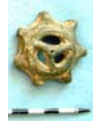

WR PLUMB BOB NEWS

2008-03
Feb. 18, 2008



Information for plumb bob collectors

Edited by Wolfgang Ruecker Germany

plumbbobwolf@t-online.de

I asked Nelson Denny to explain the term “offset measuring tool” . Here is his answer:

IMAGINE HANGING A PLUMB LINE ALONG SIDE A WALL. IF YOU TAKE A HORIZONTAL MEASUREMENT FROM THE PLUMB LINE TO THE WALL AT THE TOP AND COMPARE IT TO THE HORIZONTAL MEASUREMENT FROM THE PLUMB LINE TO THE WALL AT THE BOTTOM.....IF THE TWO MEASUREMENTS ARE THE SAME, THE WALL IS PARALLEL TO THE PLUMB LINE. THEREFORE THE WALL IS "PLUMB." IT DOES NOT MAKE A DIFFERENCE WHETHER THE "PLUMB BOB", THE WEIGHT AT THE END OF THE BOB, IS POINTED, OR SYMMETRICAL. THE WEIGHT COULD BE A ROCK OR AN IRREGULAR BASKET OF ROCKS. THE PLUMB LINE IS STILL PLUMB.

THIS IS THE FIRST AND MOST BASIC (PRIMITIVE) USE OF A PLUMB LINE. THE BOB IS ACTING AS A WEIGHT ONLY.....THE SHAPE OF THE WEIGHT HAS NO SIGNIFICANCE. I CALL THIS BASIC USE OF A PLUMB LINE, ITS USE AS AN "**OFFSET MEASURING TOOL**". THE PLUMB LINE IS "OFFSET" FROM THE STRUCTURE BEING BUILT.

ITS USEFULNESS AS AN OFFSET TOOL IS ENHANCED BY THE USE OF A SPACER, BECAUSE IT SIMPLIFIES THE MEASURING PROCEDURE.....EVEN WITH A SPACER, (WR: we will inform about **SPACERS** and their use in another issue) THE BOB NEEDS NOT BE SYMMETRICAL OR POINTED, FOR IT TO BE USEFUL. IF YOU WATCH CONCRETE MASONS WORK TODAY THEY FREQUENTLY DON'T BOTHER WITH ANYTHING AS FANCY AS A "PLUMB BOB". THEY'LL PROP UP A LOOSE BLOCK AT THE TOP AS A SPACER AND WILL HANG A BRICK OR STONE ON THE END OF THEIR LINE FOR WEIGHT.

ONLY WHEN THE BOB (THE WEIGHT) BECOMES SYMMETRICAL AND THEN POINTED, THAT THE TOOL BECOMES SIGNIFICANT IN A SECOND USEFUL CAPACITY. THAT IS, TO POINT TO AN IMAGINARY SPOT ON THE GROUND (PLANE) THAT IS DIRECTLY BELOW THE PLUMB LINE. IT IS THAT "IMAGINARY" SPOT THAT IS RECORDED WITH A MARKING INSTRUMENT ON THE GROUND OR FLOOR AND REMAINS IN PLACE, EVEN WHEN THE PLUMB BOB AND LINE IS REMOVED.

THE MORE PRECISION THAT IS DEMANDED FOR THE JOB, THE MORE SYMMETRICALLY POINTED THE BOB HAS TO BE.

IF YOU REALLY WANT TO BOGGLE YOUR MIND, PLUMB LINES ARE NEVER REALLY PARALLEL TO WALLS OR PARALLEL TO EACH OTHER.....A PLUMB LINE IN GERMANY IS NOT PARALLEL TO A PLUMB LINE IN ITALY. THEY ARE ONLY PARALLEL IN THE SENSE OF THE RELATIVE ACCURACY OF OUR MEASURING TOOL AND THE SCALE OF THE STRUCTURES WE BUILD.....

Remark WR: For more confusion see the articles of using the plumb bobs in the TAMARACK MINES/ USA: “The Tamarack mines Mystery by Donald E. Simanek”

<http://www.lhup.edu/~dsimanek/hollow/tamarack.htm>

The theme today is to show what different ways were used to fix the line to the cap. Each of this variety has his advantage and disadvantage.
I will not discuss the different shapes of the cap or tips.



WR PLUMB BOB NEWS

2008-03
Feb. 18, 2008



Information for plumb bob collectors

Edited by Wolfgang Ruecker Germany

plumbbobwolf@t-online.de

Common Cap and Plumb Line configurations:

- 1) Open hook.** An uncommon configuration used specifically in the "TILT"-mechanism in many pin ball machines. Open hooks are more commonly positioned at the top of the plumb line as in the case of many miners plummets

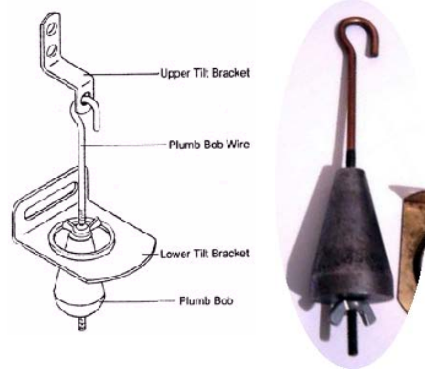

- 2) Wire eye or loop cast or threaded into the plumb bob body.** The cast-in loop wire is frequently employed in primitive lead lump castings

Eyes and loops, generally speaking, provide an adequate connection for the plumb line as long as the intended use of the tool is limited to using the plumb line as an offset measuring tool. When a bob is pointed and intentionally symmetrical, a loop or eye centered on the cap would be a poor shape to employ since the user is never really sure that the friction between line and loop is preventing the bob from hanging symmetrically.



Here a very ugly homemade modification on a nice „Perfection“ patented plumb bob ☹



- 3) Hinged wire loop.**





WR PLUMB BOB NEWS

2008-03
Feb. 18, 2008



Information for plumb bob collectors

Edited by Wolfgang Ruecker Germany

plumbbobwolf@t-online.de

4) Fixed cap with a horizontal hole through the "cap".

Like the wire eye or loop such a connection could only be employed on bobs used for offset measuring from the plumb line.

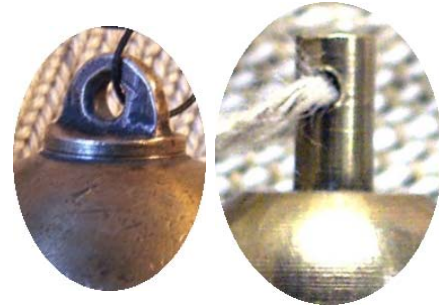

5) Fixed cap with inclined hole.

The lower part of the hole has a greater diameter than the top. So the knot can be pressed into the hole.



6) Fixed cap with horizontal and vertical hole.

The horizontal hole is BIGGER than the vertical. The knot shall rest inside of the horizontal hole, but not slip through the small vertical hole.



7) Vertical hole through the body of the plumb bob.

At the lower part of the hole it has a bigger diameter to have enough space for the knot.



8) Hinged plate with hole.

This kind exists only on Ottoman plumb bobs type 1. Often this part is lost. The pin in the joint is a simple iron wire, or a bent nail. These plates have very different shapes.



I will show the Ottoman plumb bobs in a later issue.

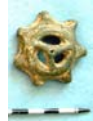

WR PLUMB BOB NEWS

2008-03
Feb. 18, 2008



Information for plumb bob collectors

Edited by Wolfgang Ruecker Germany

plumbbobwolf@t-online.de

9) Cast loop

To attach a spring hook mounted to the end of a measuring tape. Usually used for tank gauging tools.



10) . Winding the plumb line around a stone or any other irregular asymmetrical object.

No doubt, this is the most ancient configuration of a plumb line and plumb bob. It is perfectly acceptable as an accurate offset measuring device, and a technique used by masons to this day.



11) To fix a chain (patented for mining back sights)

see WR PATENT NEWS 2007-17

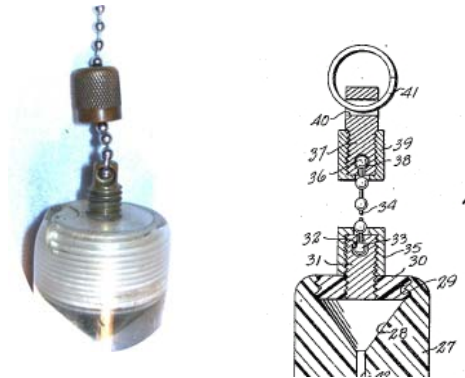

12) Cap with threaded male connection to plumb bob body.

Plumb line hole is in center top of the cap and knotted below.





WR PLUMB BOB NEWS

2008-03
Feb. 18, 2008



Information for plumb bob collectors

Edited by Wolfgang Ruecker Germany

plumbbobwolf@t-online.de

- 13) **Cap with threaded female connection** to plumb bob body.
Plumb line hole is in center top of the cap and knotted below.



- 14) **Patented STARRET cap.**
See WR PATENT NEWS 2007-16 und 2007-31
Allows for string storage and height adjustment. The cap is a very specialized high precision part.



- 15) **Patented SURVERKROP cap.**
Details see WR PATENT NEWS 2007-16
Allows for string storage and height adjustment. The cap is a very specialized high precision part.

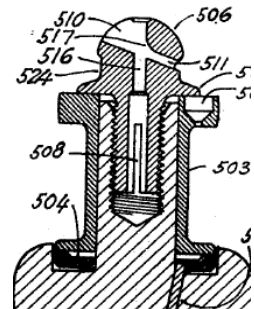

- 16) **Plumb bob fixed by rivets** to the measuring tape.
In tank gauging instruments the bob is sometimes directly fixed with rivets to a flexible measuring tape and is part of the tape length. A snap hook sometime replaces the rivet. As an oil tank gauge such bobs are not used as offset measuring tools or pointers. Rather the bob functions a weight to carry the measuring tape to the bottom of the tank, and the plumb line, the tape in this case is employed as a measuring device to determine the depth of the liquid in the tank.





WR PLUMB BOB NEWS

2008-03
Feb. 18, 2008



Information for plumb bob collectors

Edited by Wolfgang Ruecker Germany

plumbbobwolf@t-online.de

In some cases the connection of the plumb line to the cap is not a fixed point at the bottom end of the plumb line. Certain bobs allow the plumb line to pass through the cap with excess line accumulated below the cap. There are three basic cases that describe what happens to the line after it passes through a hole centered on the top of the cap. (17,18,19)

17) Patented and un-patented brakes or clamping and squeezing devices.

The addition of an extra part or parts forms collet surrounding the plumb line. Tightening the cap on to the body grips the collet which in turn grips the line and fixes the bob to a point on the line; loosening the cap allows the line to pass through freely, thus allowing vertical adjustment of the bob.

PRUTCH, BERGMAN and SPAETH

Details see WR PATENT NEWS 2007-16, 28, 44.



18) Similar to #17 a braking effect can be applied to a plumb line by leading the line vertically through the center of the cap, then laterally out the side of the plumb bob body.

Without employing extra easy to loose parts, tightening the cap clamps the line between the cap and the body, loosening the cap allows the line to pass freely.





WR PLUMB BOB NEWS

2008-03
Feb. 18, 2008



Information for plumb bob collectors

Edited by Wolfgang Ruecker Germany

plumbbobwolf@t-online.de

19) There are cases where there is no fixed attachment of the line to the cap; the cap acts as guide to plumb line only.

Below the cap the line may be wound onto a horizontal bobin or vertical reel. In these cases the braking mechanism may be applied by string friction along the treading path as it is directed to the bobin, or by applying friction to the reel itself.

(Traut/Stanley) (Common ice cream cone bobin bobs made by many manufacturers)

More on such mechanized bobs at another time.



20) Cap as a light source as in the case of miners plummets.

The parts list of miners plummets varies from conventional plumb lines and pointed bobs. In plummets, the plumb line is replaced with a gimble and chain mechanism, and the cap or the top of the bob becomes a holder for a wick to provide light.



21) What is still missing????

Please let me know.....

????

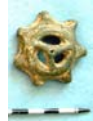

WR PLUMB BOB NEWS

2008-03
Feb. 18, 2008



Information for plumb bob collectors

Edited by Wolfgang Ruecker Germany

plumbbobwolf@t-online.de

TYPES of TIPS

1) **THE SAME material for tip and body.**

On rare occasion, the tip may be especially hardened to protect a pointed tip from being damaged.



2) **Tips may be separate pieces that are mechanically bonded to the plumb bob body in the fabrication process and are not intended for separation**



3) **Tips threaded to the plumb bob body, in male or female configuration, as a simple method of joinery of different materials. Tips may be designed specifically to be replaced.**

Additionally, some bobs have the provision of carrying a replacement part, inside the bob.

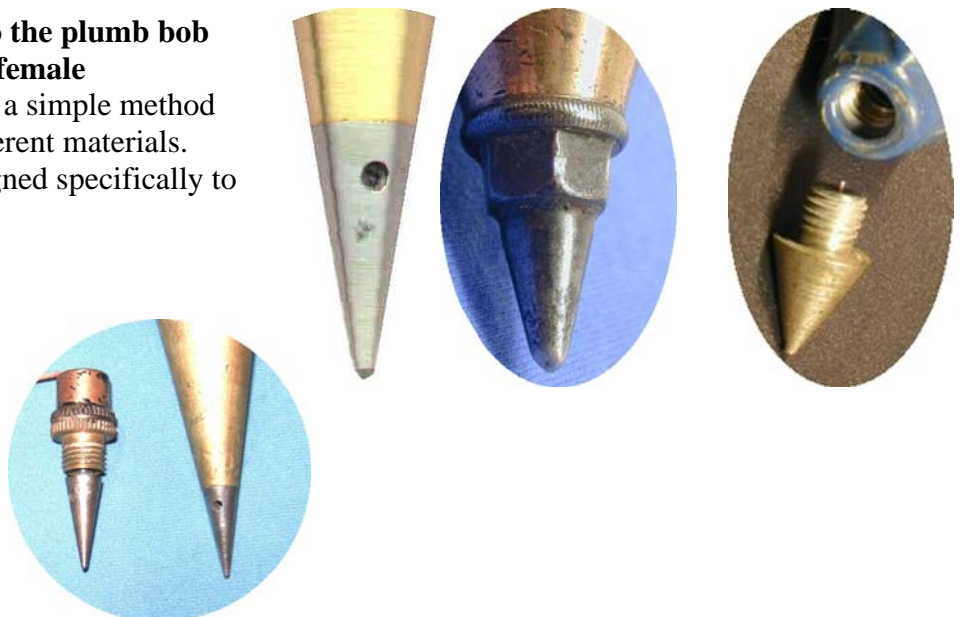

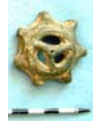

WR PLUMB BOB NEWS

2008-03
Feb. 18, 2008



Information for plumb bob collectors

Edited by Wolfgang Ruecker Germany

plumbbobwolf@t-online.de

4) "Through tips" or "Through shafts"

Certain types of bobs have tips that extend through the body of the bob to the cap. In this case the tip "points" and the shaft acts as an armature on which to hang the body of the plumb bob.

These "through tips" may be pointed cylinders, thus allowing the body of the bob to be inverted. In millwright bobs the center of gravity of the body can be altered by this method.

Some "through shafts" may be tapered as in the vast majority of "Common Sense Type" bobs, or the fancy "millwright" bobs made by Leister and Heimbach. This is technically a complex operation of fitting tapered shaft, to a tapered internal hole through the center of the plumb bob body. I do not believe that there is a benefit or improvement to a plumb bob having a tapered shaft.



5) "Reversible tips"

are tips that are double ended, that unscrew from the body, then can be inverted and screwed back in the same hole. There

are examples of reversible tips pointed at both ends. These bobs in effect, offer a spare tip if one end becomes damaged. (Berger).

Historically, however, bobs with reversible tips have a blunt end and a pointed end. As a manner of practice the worker would screw the tip in place with the blunt end out when he carried it in a pocket or tool pouch, but would invert the tip with the point out in order to use the tool. Thus, the pocket or pouch lining was saved from damage by the sharp tip, while also protecting the tip from accidental damage.



6) Flat bottom plumb bob with vertical through hole from top to bottom. This is an interesting example of a bob that is all "body", so to speak, without cap or tip.





WR PLUMB BOB NEWS

2008-03
Feb. 18, 2008



Information for plumb bob collectors

Edited by Wolfgang Ruecker Germany

plumbbobwolf@t-online.de

- 7) **Plastic ball spring mounted** for marking plumb bobs.
Patented plumb bob Patent US 5791061 Modugno Aug 1998
see WR PATENT NEWS 2007-11



- 8) **“Tip caps”** are separate pieces that are threaded in place over a pointed tip. This is another way to protect the point of the tip from damage and the pocket or tool pouch from wear. The cap often was lost.

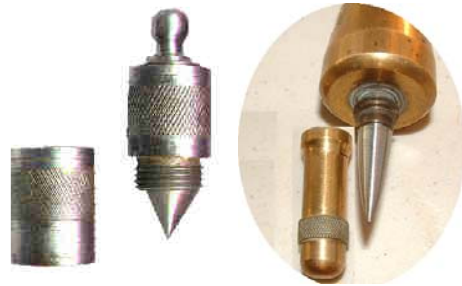

- 9) **“Tip spring”** refers to the inserion of a compression spring between the tip and the plumb bob body. The spring in effect dampens the force that can be applied to the point, thereby protecting the tip from damage. The degree of protection is related to the stiffness of the spring. There is variety of patents employing spring tips. (see **Berger**).

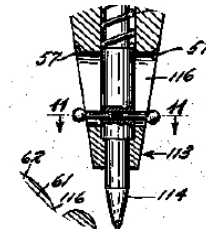

There is evidence that such springs were employed before the patent date by other bob makers. (see **Early spring tip**)

The relavance of stiffness may have some bearing on how the tool is used in practice. If you were to compare the Berger to this Early spring tip example, the Berger has a very stiff spring which supports the weight of the bob body without compression if you were to stand it upright. In the Berger, the spring only becomes effective if the bob is dropped from a height and gains some momentum in the fall, solely to protect the tip from damage. In the Early Spring tip example, by comparison, the spring is very soft and does little to protect the tip from damage. Rather, in this case, the bob is used by laying it on the floor then gently and slowly lifting it into position. Just at the point when the tip is about to lose contact with the floor, the light spring has virtually stopped all oscillation of the plumb bob body. Thus there may be two entirely different reasons to have a “tip spring.”.



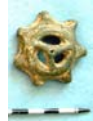

WR PLUMB BOB NEWS

2008-03
Feb. 18, 2008



Information for plumb bob collectors

Edited by Wolfgang Ruecker Germany

plumbbobwolf@t-online.de

11) Tip hollow for light or laser beam/ray

Used in all plumb bobs with laser rays. See WR PATENT NEWS 2007-08

Tip hollow for transmission of battery powered incandescent lights (Marcos) (Griffin) The extreme shortcoming of these

examples is that they have to be used in very shady if not dark locations, an uncommon working environment for the use of a plumb bob.

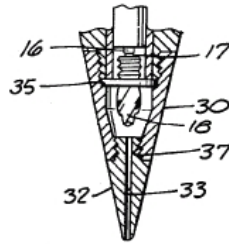

UPSIDE DOWN for Australian users:

Other than several Laser instruments one example of a laser instrument bears any resemblance to a recognizable plumb bob, points like an ordinary bob with its tip, sits in a gimbed rack pointing at the floor and casts the laser light upward through a hole in the center of the cap.



10) I didn't find yet a **tip made by soft / non-rigid material** to reduce the demolition of the tip. Usually the tips are harder than the body.

?????

11) What tip is still missing? Please let me know.

I did not talk about the hundreds of different shapes of the tip, but only of the different kinds.

Other references to references to "caps" and "tips" and related subjects, see "THE PLUMB LINE CONTINUUM" by Bruce Cynar and edited by Nelson Denny.

"Parts of the Plumb Bob" (page 2)

"The Great Shape Debate" (pages 9, 10, 13, 14, 15, 16, 36).

"Protecting the Point" (page 37 and 39)

Thanks to Nelson Denny for the help and teamwork to write this article.