

PATENT NEWS especially for PLUMB BOB COLLECTORS

WR PATENT NEWS # 2007-28

US198470S PRUNCH 1964 PLUMB BOB
US179330S SUVERPROP 1956 PLUMB BOB
and
US2384914 HOAGLAND 1945 PLUMB BOB REEL
US2509959 BYNUM 1950 ADJUSTABLE PLUMB BOB
US2848818 KRASOVER 1958 PLUMB BOBS

THEME: Design patents

United States Patent Office Des. 198,470
Patented June 16, 1964

198,470

PLUMB BOB

Joseph Prutch, 317 Sepulveda St., San Pedro, Calif.

Filed May 3, 1963, Ser. No. 74,731

Term of patent 14 years

(Cl. D52-1)

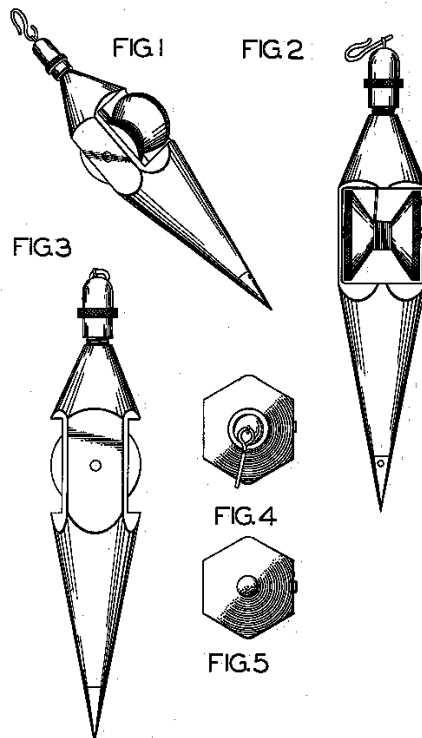

FIGURE 1 is a perspective view of a plumb bob, showing my new design;

FIGURE 2 is a front elevational view thereof;

FIGURE 3 is a side elevational view thereof;

FIGURE 4 is a top plan view thereof; and

FIGURE 5 is a bottom view thereof.

I claim:

The ornamental design for a plumb bob, as shown.

References Cited in the file of this patent

UNITED STATES PATENTS

2,384,914	Hoagland	Sept. 18, 1945
2,509,959	Bynum	May 30, 1950
2,848,818	Krasover	Aug. 26, 1958

PATENT NEWS especially for PLUMB BOB COLLECTORS

As "REFERENCES CITED" we find:

BUT NOT THE WELL KNOWN STANLEY
PLUMB BOB WITH THE TRAUT
patent.US151521 FROM 1874.
Details in other WR PATENT NEWS.

References Cited in the file of this patent

UNITED STATES PATENTS

2,384,914	Hoagland -----	Sept. 18, 1945
2,509,959	Bynum -----	May 30, 1950
2,848,818	Krasover -----	Aug. 26, 1958

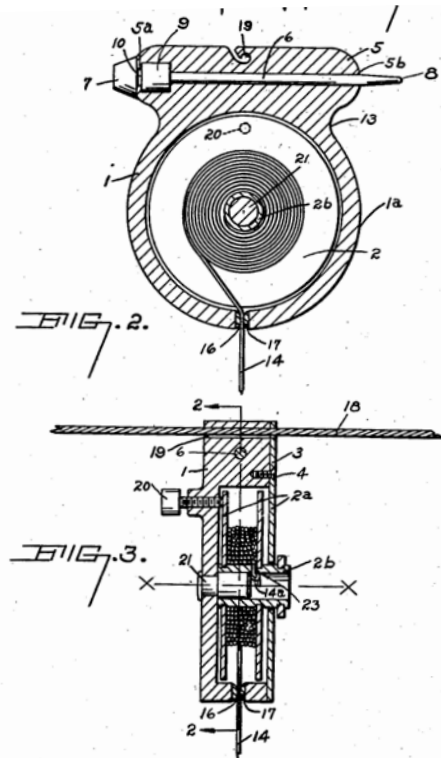

Aug. 26, 1958

J. A. TRAUT.
Plumb-Bobs.



J. KRASOVER

PLUMB BOBS

Filed Aug. 14, 1956

C. G. BYNUM
ADJUSTABLE PLUMB BOB
Filed Jan. 10, 1948

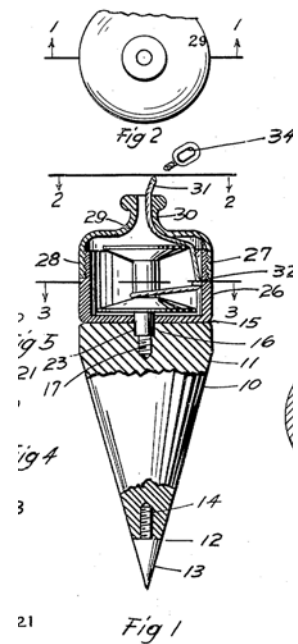

2,848,818

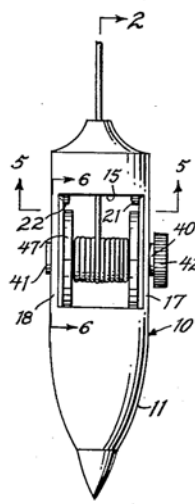

Fig. 1.

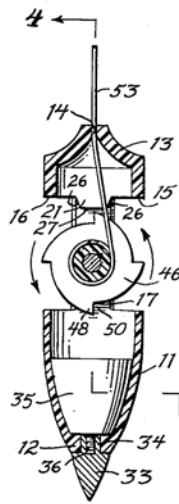

Fig. 2.

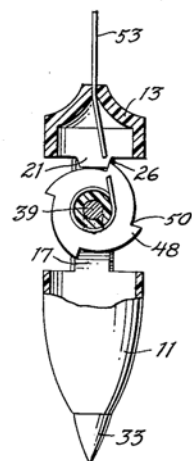
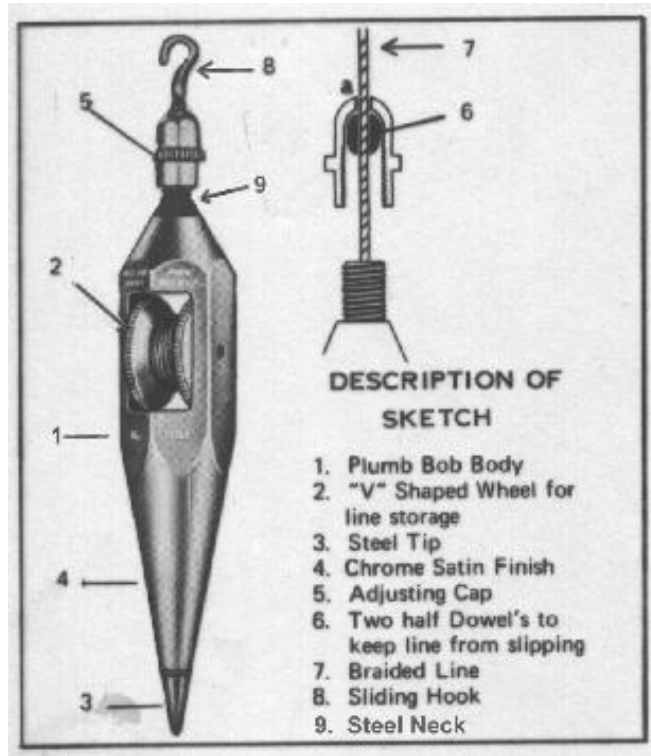

Fig. 3.

PATENT NEWS especially for PLUMB BOB COLLECTORS

Recently I bought one, so I can give you some detailed information and pictures:

This plumb bob is also sold as "SPEED BOB", nickel plated and it is very long (8 inch / 20 cm).



When I picked up the plumb bob at the customs I directly checked if the part 6 "TWO HALF DOWEL'S to keep the line from slipping" were still there, because I could not find a BRAKE on the wheel like the STANLEY 1874.

They were inside! ☺

It is marked: DES PAT 198470 MADE IN USA No 20

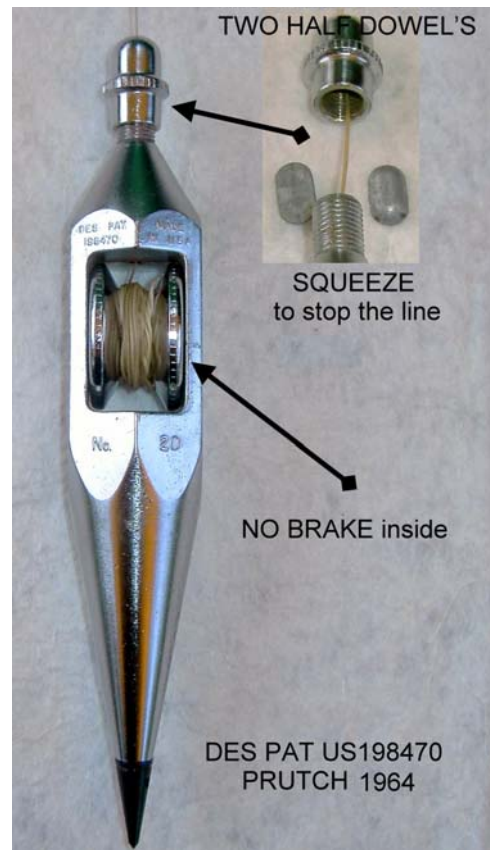

PATENT NEWS especially for PLUMB BOB COLLECTORS



PATENT NEWS especially for PLUMB BOB COLLECTORS

Another DESIGN patent from SUVERKROP (see also WR PATENT NEWS 2007-16)

United States Patent Office

Des. 179,330
Patented Nov. 27, 1956

179,330

PLUMB BOB

Low Suverkrop, Bakersfield, Calif.

Application December 17, 1954, Serial No. 33,595

Term of patent 14 years

(Cl. D52-1)

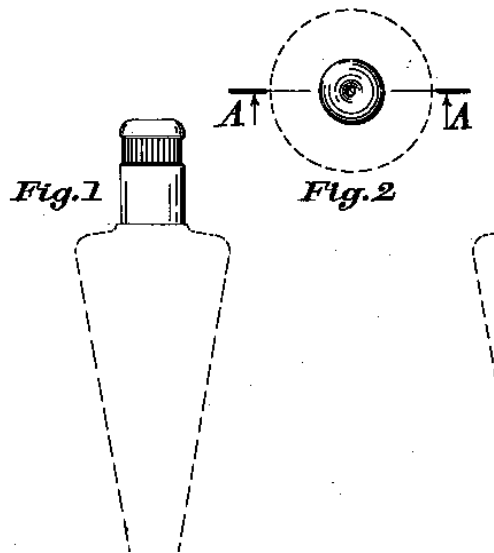

References Cited in the file of this patent

UNITED STATES PATENTS

D. 32,793	Fauber	June 5, 1900
D. 116,412	Reckford et al.	Aug. 29, 1939
1,274,966	Wentz	Aug. 6, 1918
1,848,142	Peirce	Mar. 8, 1932

OTHER REFERENCES

Tristate Electrical Supply Co. Catalog No. 7, © 1946, upper left of page 97.

Dietzgen Catalog (Drafting Supplies), © 1946, page 495.

All the REFERENCES have nothing to do with PLUMB BOBS:

- FAUBER -> LOCK NUT
- RECKFORD -> PENCIL TIP
- WENTZ -> PAPER CLIPPER
- PEIRCE -> ATTACHING DEVICE

The plumb bob is sold as BRUNING KWICK BOB Mount Prospect Illinois SUVERKROP PAT# 179330 14 oz.