

SUMMMERY

of the

WOLF'S PLUMB BOB NEWS

2007 until 2010

Wolf Ruecker

plumbbobwolf@t-online.de

www.plumbbobcollectors.info

Date **WRPN# -- THEME – PATENTS MENTIONED**

Jan. 02, 2007: **2007-01 US carrot shape**
US2006 0242852 LIN from 2006 CONSTRUCTION USE PB STRUCTURE



PL.14
200001
FIG.1

Jan. 09, 2007: **2007-02 PB with handle**
FR2823301 MESSIN from 2002

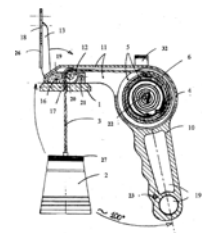

Jan. 16, 2007: **2007-03 Flat bottom + spacer**
BE881379 VERSCHOREN 1980 PLUMB BOB



Jan. 23, 2007: **2007-04 Plumb bob + case**
US266671 BERGEN 1882 PLUMB BOB
US5426869 LEE 1995 PLUMB BOB ASSEMBLY



Jan. 30, 2007: **2007-05 Movable pin**
FR408828 CAMION FRERES 1909 PLUMB BOB FOR ARCHITECTS
US630262 NACKE 1899 PLUMB BOB
US485376 FULLER 1892 PLUMB BOB
US3113387 BEAN 1963 PLUMB BOB
US1025828 PAUL 1912 PLUMB BOB

991
AUX FORGES DE VULCAN PARIS
1914



Summery WR PATENT NEWS

Date **WRPN# -- THEME – PATENTS MENTIONED**

Feb. 06, 2007: **2007-06 Flat spacer**
 ES249301 CANCIO 1980 PLUMB BOB
 US3766659 QUENOT 1973 PLUMB BOB
 US4300290 ZALEWSKI 1981 VERTICAL SIGHT ADJUSTER
 US1745027 OXFORD 1930 PLUMB BOB



Feb. 13, 2007: **2007-07 Spring winding**
 FR972955 BERTHET 1950 PLUMB BOB WITH INTERNAL REEL
 US30612 CHAPPEL 1860 LEVEL
 US279316 AVERY 1883 PLUMB BOB
 US599178 GWILLIAM 1898 SELF WINDING PLUMB BOB
 US625181 MARTIN 1899 PLUMB BOB

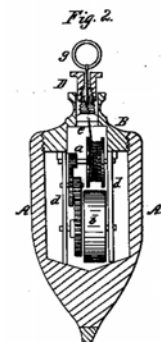

Feb. 21, 2007 **2007-08 + update Light/laser plumb bob**
 US5537205 COSTA 1996 SELF LEVELLING LASER PB
 US4106207 BOYETT 1978 POINT TO POINT.....
 DE356839 BRAUNSCHU 1922 PLUMB BOB
 FR547411 DACHEUX 1922 PLUMB BOB WITH LIGHT
 DE843602 BOEHM 1949 BEAMING PLUMB BOB
 DE19934984 BAEDER 2002 PLUMB BOB
 US4625428 GRIFFIN 1986 LIGHTED PLUMB BOB



Feb. 28, 2007 **2007-09 Sold as "patented plumb bob" P b**
 "Coffee filter glass p b" US2370674 LUCIA 1945
 "Valve means" GB520068 ANDREASEN 1940
 ”



Mar. 6, 2007 **2007-10 Pocket plumb bob**
 ES264279 FELIX 1982 POCKET PLUMB BOB

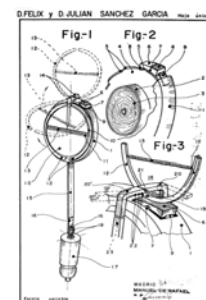

Summery WR PATENT NEWS

Date **WRPN# -- THEME – PATENTS MENTIONED**

Mar. 13, 2007 2007-11 + update **Marking plumb bobs**
US5791061 MODUGO 1998 MARKING PLUMB BOB
DE7137292 MUELLER 1972 MARKING PLUMB BOB
US870576 McQUAID 1907 PLUMB BOB
GB190506166 TALLACK 1905 CENTREMARKING APPARATUS
US995872 JOICE 1911 PLUMB BOB
US1949652 Mc LAWS 1934 PLUMB BOB
US2795053 WOHLSTROM 1957 SELF MARKING PLUMB BOB
US267655 VAJEN 1882 PLUMB BOB



Mar. 20, 2007 2007-12 **Shaft centring device**
US953131A1 FERRIS 1910 SHAFT-CENTRING DEVICE
US1018863 BARRICKMAN 1912 SHAFT LEVEL
US1134125 HAFNER 1915 APPLIANCE FOR LEVELING SHAFTING
US1235279 BERNIER 1917 SHAFT ALINER
US2016573 BECK 1935 PLUMB BOB SUPPORT
US5074509 VAN ORDEN 1991 PLUMB BOB SUPPORT



Mar. 27, 2007 2007-13 **CARTER Gyrostatic GIMBALS**
GB190800163 CARTER 1908 GYROSTATIC PLUMB BOB



Apr. 3, 2007 2007-14 + update **Design patents**
US167157S Mc CORD 1952 PLUMB BOB SHEATH
US51420S MOFFAT 1917 DESIGN FOR A PLUMB BOB
US1755395 DUNN 1955 GRAIN THERMOMETER HOUSING



Apr. 10, 2007 2007-15 **Mining plummet / lights**
US1081829 HIGGINS 1913 SIGHTING TARGET
US287580 ROACH 1883 PLUMMET LAMP
US792944 STOW P B SUSPENSION HOOK
US1231925 Mc KAY 1917 LAMP
US1052075 MARTIN 1973 PLUMMET LAMP
US113519 WALLACE 1914 PLUMB LIGHT



Summery WR PATENT NEWS

Date **WRPN# -- THEME – PATENTS MENTIONED**

Apr. 17, 2007 **2007-16 Fix the string (adjustable pb)**
US2469583 SUVERKROP 1949 ADJUSTABLE P B
US2594823 SUVERKROP 1952 PLUMB BOB
US2965973 SUVERKROP 1960 REEL FOR P B
US2985964 SUVERKROP 1961 PLUMB BOBS
US3056211 SUVERKROP 1962 ADJUSTABLE P Bs
US773547 COLEMAN 1904 ADJUSTABLE P B + LINE REEL
US833699 STARRETT 1906 STARRETT
US1502804 WINDHAM 1923 PLUMB BOB
US1590410 BERNARD 1926 PLUMB BOB
US2381698 SIRECI 1945 PLUMB BOB
US3405450 PEACOCK 1968 PLUMB BOB



Apr. 24, 2007 **2007-17 Illuminated back sights + targets**
US2538475 SKRASTIN 1951 SURVEYOR'S ILLUMINATED BACKSIGHT
FR547411 DACHEUX 1922 LIGHTING PLUMB BOB
DE441880 DOMINIT 1927 TARGET
US1101375 WUTH 1914 TARGET FOR PLUMB BOB STRINGS
US1227631 KOLESCH SURVEYOR'S TARGET
GB190900525 PATTERSON 1909 GAS DETECTING LAMP



May 1, 2007 **2007-18 Sold as "pat. Plumb bob" 2**
"Land anchor for posts" US610184 HILL 1898
"Handle or pull for water closets" US334412 BATE 1886



May 8, 2007 **2007-19 Flat French + STANLEY**
GB191101960 SHORTT 1911 IMPROVEMENTS IN PLUMBING DEVICE
US3885319 WEST 1975 VERTICAL + HORIZONTAL P B
US3866329 ROLLBAND 1975 PLUMMET



May 15, 2007 **2007-20 Chalk lines**
US65057 CARTER 1867 CHALK LINE HOLDER
US1567976 MYERS 1925 CHALK LINE HOLDER



Der Schnurschlag

Summery WR PATENT NEWS

Date **WRPN# -- THEME – PATENTS MENTIONED**

June 26, 2007 2007-26 **Barbara and Robert (figural pbs)**
US5720112 ADAMS 1998 Asymmetrical plumb bob



Jul. 3, 2007 2007-27 **Sold as “patented pb” 3**
“Medical plumb bob” US588483 DR SANCHE 1897
“Ammunition / bullets” US469631 DRIGGS 1892



Jul. 10, 2007 2007-28 **Design patents 2**
US179330S SUVERKOP 1956 PLUMB BOB
US198470S PRUNCH 1964 PLUMB BOB
US2384914 HOAGLAND 1945 PLUMB BOB REEL
US2509959 BYNUM 1950 ADJUSTABLE PLUMB BOB
US2848818 KRASOVER 1958 PLUMB BOBS



Jul. 17, 2007 2007-29 **Stair builders plumb bob**
US160471 ROBINSON 1875 STAIRBUILDERS RULE
US454701 BARNES 1891 STAIRBUILDERS PLUMB LEVEL



Jul. 24, 2007 2007-30 **Winders fixed to the wall**
US2384914 HOAGLAND 1945 PLUMB LINE REEL
US2376407 WELLS 1945 PLUMB BOB REEL
US3521369 JONES 1970 UNIVERSAL PLUMB BOB LEVEL DEVICE
US5704131 COURTNEY 1998 ADJUSTABLE PLUMB BOB AND LINE
US225174S QUENOT 1972 PLUMBLINE (design pat)
FR2040603 QUENOT 1971 FIL A PLOMB
GB882595 PEARMAN 1961 PLUMB LINE REELING DEVICE



Summery WR PATENT NEWS

Date **WRPN# -- THEME – PATENTS MENTIONED**

Jul. 31, 2007 **2007-31 Mercury or lead filled**
US833699 STARRETT 1906 PLUMB BOB
US787896 CONVERSE 1905 PLUMB BOB (PERFECTION)



Aug. 07, 2007 **2007-32 Internal reel**
US5151521 TRAUT 1874 PLUMB BOB (Stanley)



Aug. 14, 2007 **2007-33 Curiosities**
DE1756887UU GEHRER 1957 SAW AND PLUMB BOB
GB190927693A SANDOW 1909 SPINAL DEFORMATION
GB2405122A MONTFORD 2005 SAW AND PLUMB BOB
US1170591WHITE1916 COMBINATION TOOL
DE2553422A1 PRAHL 1977 SAW WITH LEVELS

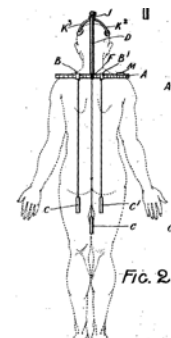

Aug. 21, 2007 **2007-34 Mechanized plumb bobs**
US1357270 BUSH 1920 AUTOMATICAL PLUMB BOB
US2136072 BUSH 1938 AUTOMATICAL PLUMB BOB



Aug. 28, 2007 **2007-35 Variable plumb bobs**
US267655 VAJEN 1882 PLUMB BOB
DE61539 HÄUSERMANN 1892
US329573 LEIDGEN 1885



Summery WR PATENT NEWS

Date **WRPN# -- THEME – PATENTS MENTIONED**

Sept. 04, 2007 **2007-36 diverse plumb bobs**
US409917 CAMERON 1889 PLUMB BOB
US331144 LAWLER 1885 PLUMB BOB FOR GAS FITTINGS
US4947556 PEIL 1990 PLUMBERS'S LEVEL

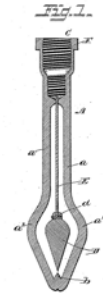

Sept. 11, 2007 **2007-37 OIL GAUGES**
US1947592 HALLER 1934 COMBINATION GAUGE BOB
AND THERMOMETER
GB356370 RABONE 1931 IMPROVEMENTS IN PLUMB BOBS FOR
USE IN MEASURING TAPES
US1680297 LEWIS 1927 PLUMB BOB



Sept. 18, 2007 **2007-38 Mechanized plumb bobs**
US2849805 KRUSE 1958 RETRACTABLE PLUMB BOB
US3064356 KRUSE 1962 RETRACTABLE PLUMB BOB
US3284914 KRUSE LINE-RETRIVING PLUMB BOB
US702288 CURRY 1902 PLUMB BOB
US831775 CURRY 1906 PLUMB BOB



Sept. 25, 2007 **2007-39 LEE VALLEY and VERITAS**
US5426860 LEE 1995 PLUMB BOB ASSEMBLY
Design US393219 McGuire 1998 PLUMB BOB



Oct. 02,2007 **2007-40 Russian plumb bob**

SU1753274 FLESS 1992 PLUMB BOB
SU1044983 PEREGUDOW 1983 PLUMB BOB
DE96450A SIMON Loth mit Wasserwaage 1898
US2135211 JOHNSON 1938 PLUMB BOB



Summery WR PATENT NEWS

Date **WRPN# -- THEME – PATENTS MENTIONED**

Oct. 09, 2007 2007-41 **Mechanized plumb bobs**
US2420096 ROOSE 1947 PLUMB BOB
US1274662 ARMOUR 1918 PLUMB BOB
US1076569 GAMBLEE 1913 PLUMB BOB



Oct. 16, 2007 2007-42 **Combination tool**
US316530 DOWNIE 1885 CHALK LINER AND PLUMB BOB



Oct. 23, 2007 2007-43 **Combined chalk line box + pb**
US2589500 LANDON 1952 COMBINED CHALK LINE BOX
AND PLUMB BOB
US1586654 CONWAY 1926 COMBINED CHALK LINE
AND PLUMB BOB



also mentioned:
US873686 SHARP 1907 CHALK LINE HOLDER
CH235630 ZAUGG 1945 COMBINED CHALK LINE
AND PLUMB BOB FOR PAINTERS AND PAPERING

Oct. 30, 2007 2007-44 **Mechanized plumb bobs**
US1876473 SPAETH 1932 COMBINATION PLUMB BOB CHALK LINE



Nov. 06, 2007 2007-45 **wind up cord**
US584803 WILCOX 1897 PLUMB BOB



Summery WR PATENT NEWS

Date **WRPN# -- THEME – PATENTS MENTIONED**

Nov. 13, 2007 2007-46 **Mechanized plumb bobs**
US3027977 KNAUS 1962 TOOLS (plumb bob w chalk line)
DE DRGM 193259 SCHULTE 1904 PLUMB BOB



Nov. 20, 2007 2007-47 **Mechanized plumb bobs**
GB190719687A WIESNER AUS 1907
plumb bob internal reel

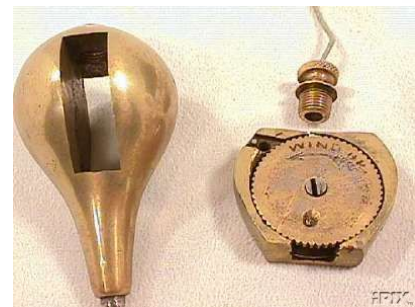

Nov. 27, 2007 2007-48 **sundries**
US1530832 JOHNSTON 1925 GAUGE with plumb bob
US1704237 ARMS 1929 PLUMB BOB
US4625428A1 GRIFFIN 1986 lighted plumb bob



Dec. 04, 2007 2007-49 **New patents of the plumb bob / special points**

US5720113 BARTIMUS 1998 PLUMB BOB and
STRING LINE ANCHORING DEVICE
US162237 BARTIMUS 2002 SHEATH FOR
COMBINED STRING LINE ANCHOR and PB
US1098033 FRIENDSHIP 1914 PLOMB and CHALK LINE
US3113387 BEAN 1963 PLUMB BOB with RETRACTABLE POINT
US2594823 SUVERKROP 1952 PLUMB BOB
US5157843 BARCEWSKI 1992 High accuracy self setting plumb bob

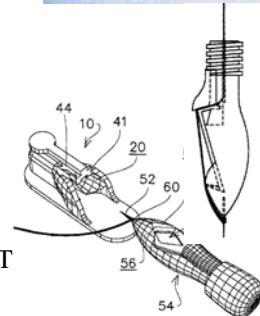

Dec. 11, 2007 2007-50 Last issue of 2007: **PATENT CALENDAR 2008**

Printable Calendar with patents and pictures

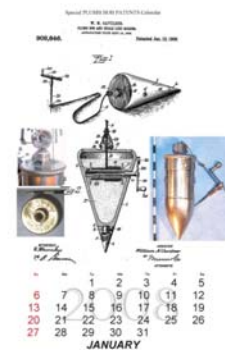

THE END

PLUMB BOB PATENTS
CALENDAR 2008..



Wolf's PLUMB BOB NEWS

2008-complete

SUMMERY

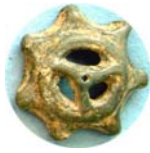

Information for plumb bob collectors

Editor: Wolfgang Ruecker

plumbbobwolf@t-online.de

#. **TITLE / CONTENTS**

2008-05 DEPTH MEASURING (13 pp)

1. OIL TANK GAUGING
2. SOUNDING WEIGHTS
3. DEPTH MEASURING OF WELLS



2008-06 GERMAN PLUMB BOBS (14 pp)

1. INTRODUCTION
2. THE "HAMBURG STYLE"
3. LEISTNER & HEIMBACH
4. GERMAN MANUFACTURED PLUMB BOBS
5. WHAT SHAPES were used in GERMANY (after 1800)?
6. CYLINDRICAL PLUMB BOB
7. MUNITION
8. DECIMAL SCALE
9. OTHERS



2008-07 REPORT 2nd Int. PLUMB BOB COLLECTORS MEETING in PARIS (11 pp)



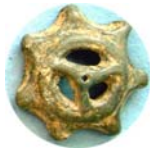

Wolf's PLUMB BOB NEWS

2008-complete

SUMMERY



Information for plumb bob collectors

Editor: Wolfgang Ruecker

plumbbobwolf@t-online.de

#. **TITLE / CONTENTS**

2008-08 THE PLUMB BOB AND ITS RELATIVES (15 pp)

1. INTRODUCTION
2. THE PLUMB BOB and ITS RELATIVES (overview)
3. PLUMB BOBS USED AS DEPTH MEASURING GAUGES
4. PLUMB BOBS AS SYMBOLS
5. PLUMB BOB "jigs"
6. OTHER INSTRUMENTS THAT EMPLOY PLUMB BOBS TO MAKE THEM WORK
7. THE PENDULUM
8. MECHANICAL PLUMB BOBS
9. FISHING SINKERS
10. PLUMB BOB NOVELTIES
11. PLUMB BOBS AND CHALK LINES
12. ANYTHING ELSE

THE PLUMB BOB and ITS RELATIVES

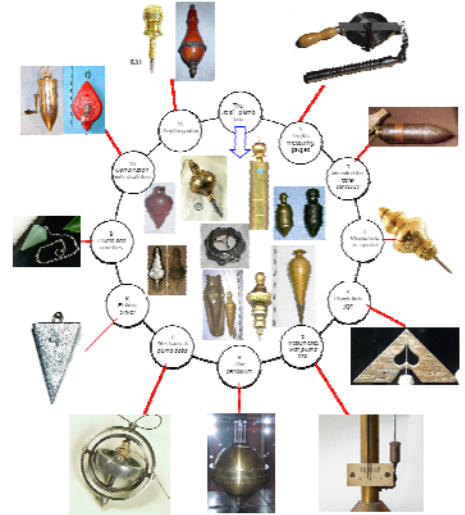

2008-09 THE IMPORTANCE OF CATALOGUES TO THE PLUMB BOB COLLECTOR (23 pp)

1. COVERS
2. HISTORY OF THE MANUFACTURES OR DISTRIBUTORS
3. YEAR / DATE
4. CURRENCY
5. PROFESSIONS
6. MARKS / NAMES / LOGOS
7. TECHNICAL INFORMATION
8. MATERIAL
9. NEWS
10. ADDITIONAL INFORMATION
11. PATENT INFORMATION
12. DIFFERENT QUALITY
13. ACCESSORIES
14. CONTAINERS /BOXES
15. SELLING ABROAD
16. PERIOD OF PRODUCTION
17. PARTS OF PLUMB BOBS
18. OTHER MEASURING TOOLS
19. DIFFERENT PRESENTATION IN THE COUNTRIES
20. OTHER TOOLS, NO PLUMB BOBS



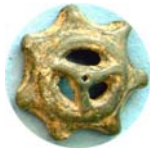

Wolf's PLUMB BOB NEWS

2008-complete

SUMMERY



Information for plumb bob collectors

Editor: Wolfgang Ruecker

plumbbobwolf@t-online.de

#. **TITLE / CONTENTS**

2008-10 **WOODEN AND METAL SPACERS (21 pp)**

1. INTRODUCTION
2. PATENTS; PICTURES; CATALOGUES
3. COLLECTION RICCARDO CHETONI
4. OTHER COLLECTIONS
5. FRENCH PATENT
6. COLLECTION ERIC KLIMP (part 1)
7. COLLECTION WOLFGANG RUECKER
8. OTTOMAN PLUMB BOBS with spacer.
9. COLLECTION ERIC KLIMP (part 2)



2008-11 **HISTORY OF CHALK LINE INSTRUMENTS IN RELATION TO PLUMB BOBS (14 pp)**

1. INTRODUCTION:
2. CHALK LINES IN ASIA
3. General
4. MAKING A SUMITSUBO
5. USE OF THE CHALK LINE (SUMITSUBO)
6. DIFFERENT CHAPES OF THE SUMITSUBO
7. INTERNATIONAL HISTORY
8. BASIC TOOLS
9. EUROPE
10. JAPAN + CHINA
11. AMERICA
12. COMBINATION TOOLS
13. INTERNATIONAL CHALK LINE HISTORY (overview)



2008-12 **HUNDRED YEARS OLD PATENTS (14 pp)** PLUMB BOB PATENTS FROM 1908

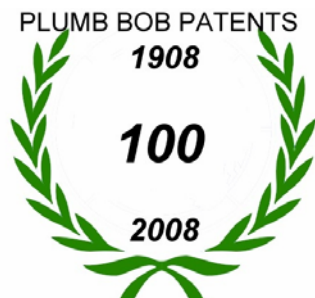

2008-13 **GREETING CARDS** from / to FELLOW COLLECTORS (7 pp)



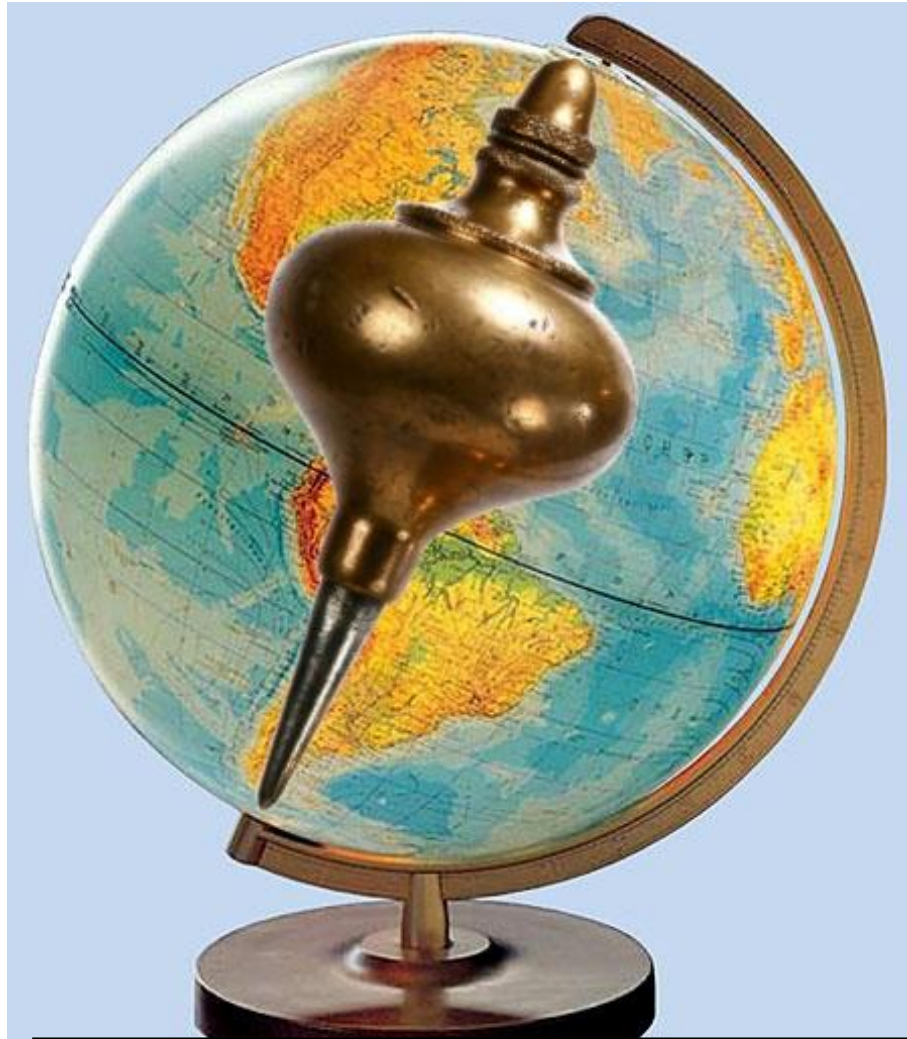

SUMMARY 2009

WOLF'S PLUMB BOB NEWS 2009

All 12 issues

Information for plumb bob collectors

Edited by Wolf Ruecker

plumbbobwolf@t-online.de

www.plumbbob.de

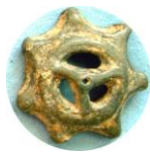

Wolf's PLUMB BOB NEWS

2009-complete
SUMMARY
of all 12 issues



Information for plumb bob collectors

Editor: Wolf Ruecker

plumbbobwolf@t-online.de

#. **TITLE / CONTENTS**

date: Dec.1, 2009

2009-01

THE PLUMB LEVELS (18 pp)

1. GENERAL
2. SHAPES
3. MATERIAL
4. ADVANTAGES
5. THE USE
6. PATENTS
7. PLUMB LEVELS IN CATALOGUES
8. PICTURES FROM COLLECTIONS

page 8

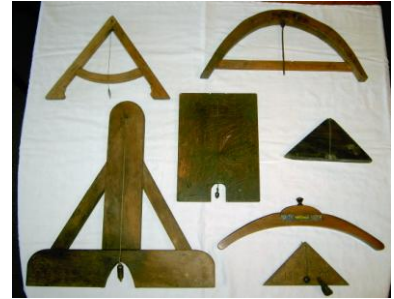

2009-02

NEW WEBSITE www.plumbbob.de (4pp)

1. Content of the website for plumb bob collectors
2. www.plumbbob.de

page 28

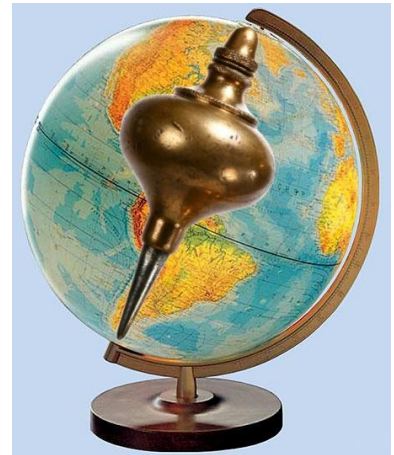

2009-03

MINING PLUMMETS (20 pp)

1. INTRODUCTION
2. MINE SURVEYORS AT WORK
3. GERMAN MINING MUSEUM
4. PLUMB BOBS FROM DOMINIT
5. DOMINIT MINING LAMP Type BOM
6. AMERICAN MINING PLUMMETS

page32



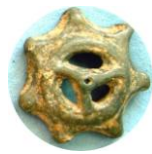

Wolf's PLUMB BOB NEWS
2009-complete
SUMMARY
of all 12 issues



Information for plumb bob collectors

Editor: Wolf Ruecker

plumbbobwolf@t-online.de

#. TITLE / CONTENTS

2009-04

page 52

HYPSONETERS (20 pp)

1. INTRODUCTION
2. TREE HIGHT MEASURING
3. FAUSTMANN'S MIRROR HYPSONETER
4. AMERICAN CATALOGUES
5. GERMAN CATALOGUES
6. UNIVERSITY DRESDEN GERMANY
7. COLLECTION WOLF RUECKER
8. OTHER SHAPES
9. HOW OLD IS MY FAUSTMANN HYPSONETER
10. CONCLUSION

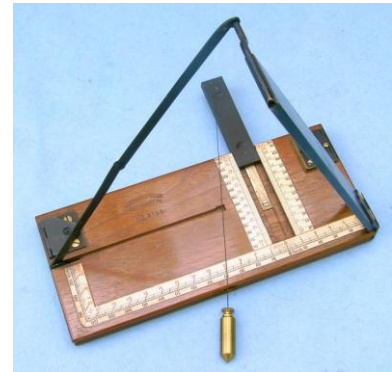

2009-05

page 75

**FREQUENTLY ASKED QUESTIONS AND ANSWERS
ABOUT PLUMB BOBS OF THE WORLD (11 pp)**

1. Why we need plumb bobs?
2. How long have plumb bobs been in use?
3. What trades use plumb bobs?
4. What are the basic shapes of plumb bobs?
5. Are different shapes of plumb bobs favored in different countries?
6. What materials are used to make plumb bobs?
7. Outside the English speaking world, what are plumb bobs called?
8. Are there many plumb bob collectors in the world?
9. How much plumb bobs do you have or how much plumb bob shapes exist?
10. How do you get information about plumb bobs?
11. Are there any museums or exhibitions with plumb bobs?
12. How heavy is the lightest and heaviest plumb bob?
13. How do you get plumb bobs?
14. How expensive are plumb bobs?
15. What is special about plumb bobs?
16. Are there any patented plumb bobs?
17. What things are called plumb bob?
18. Are plumb bobs still produced in our days?
19. Why do people collect plumb bobs?
20. Why do you collect also levels, inclinometers and chalk lines?



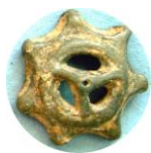

Wolf's PLUMB BOB NEWS

2009-complete
SUMMARY
of all 12 issues



Information for plumb bob collectors

Editor: Wolf Ruecker

plumbbobwolf@t-online.de

#. **TITLE / CONTENTS**

2009-06

page 87

THE PLUMMET / PLUMB BOB OF WASHINGTON MONUMENT in Washington D. C. U. S. A. (14 pp)

1. INTRODUCTION
2. INFORMATION FROM OLD BOOKS
3. DATA RELATIVE TO WASHINGTON MONUMENT
4. BENT IN THE SUN
5. THREE PLUMMET WIRES during construction
6. THE LONGEST WIRE PENDULUM OF THE WORLD?
7. THE PLUMMET OF THE WASHINGTON MONUMENT
8. WHY DID THEY INSTALL THE PLUMMET?
9. WHERE WAS THE SYSTEM LOCATED?
10. MR. GREEN INSTALLED THE PLUMMET APPARATUS
11. PLUMMET IN VESSELS CONTAINING LIQUID
12. AN OWL ON A CLOCK OF PRESIDENT HAYES AND THE PLUMMET
13. HIGHEST BUILDING IN 1884
14. WHERE IS THE PLUMB BOB NOW?
15. CONCLUSION



2009-07

page 101

TIDBITS OF CURIOUS INFORMATION ON THE SUBJECT OF PLUMB BOBS (20 pp)

1. INTRODUCTION
2. ANCIENT PLUMB BOB FROM A SWISS MUSEUM
3. ANCIENT CARPENTER'S TOOLS 1874
4. ANCIENT PLUMB BOBS FROM POMPEII / GREECE
5. PLUMB BOB AS AN EXCUSE
6. PLUMB BOB, RULE AND SPACER COMBINED
7. PLUMB BOB AS A WEAPON
8. ACCIDENT BY USING A PLUMB BOB
9. MECHANICAL PLUMB BOB
10. PLUMB BOB MOLD
11. DO IT YOURSELF PLUMB BOB HOLDER
12. THE DEVICE THAT WOULD PUT AN END TO PLUMB BOBS
13. NEW SHAPES OF MINING PLUMMETS
14. WINGED MINING PLUMB BOB
15. PLUMB BOB HOLDER FOR TRANSIT LEG
16. PROBLEMS WITH HOLLOW FILLED PLUMB BOBS (1896)
17. THE SHAPE DEBATE
18. PLUMB BOBS IN THE NEPEAN TUNNEL IN AUSTRALIA 1888
19. CONCLUSION

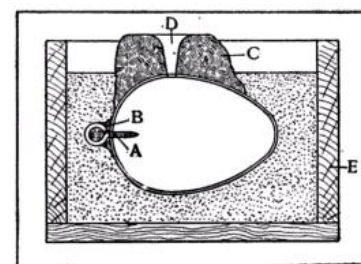

Mold for a Plumb-Bob

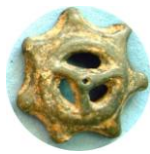

Wolf's PLUMB BOB NEWS
2009-complete
SUMMARY
of all 12 issues



Information for plumb bob collectors

Editor: Wolf Ruecker

plumbbobwolf@t-online.de

#. TITLE / CONTENTS

2009-08

page 122

ANATOLIAN / OTTOMAN PLUMB BOBS (26 pp)

1. INTRODUCTION
2. DIFFENT TYPES OF OTTOMAN PLUMB BOBS
3. REGION
4. TYPE 1
5. TYPE 2
6. TYPE 3
7. TYPE 4
8. TYPE 5 TERAZI (balance)
9. USE OF TYPE 5 AND HISTORICAL BACKGROUND
10. SU TERAZI (water towers)
11. WHAT WAS USED LATER?
12. PLUMB BOBS ON TOMB STONES etc.
13. ADDITIONAL INFORMATION
14. CONCLUSION
15. SUPPLEMENT for Fellow Collectors from France (en français)



2009-09

page 150

“PLUMB BOB” meets “PLANE”.
THE PLANE MUSEUM Gerhard Schmitz
in Langenfeld / Germany (14 pp)

1. INTRODUCTION
2. WELCOME
3. VISITORS
4. PLUMB LEVELS
5. PLUMB BOBS
6. CHALK LINES
7. WOODWORKING TOOLS
8. BASEMENT / STORAGE
9. LOOK FORWARD



2009-10

page 165

SOME NEW PATENTS ABOUT PLUMB BOBS (10 pp)

1. INTRODUCTION
2. PLUMB BOB BARBARA
3. INVENTOR JUSTUS A. TRAUT
4. FISH LURE AND HOOK RETRIEVER
5. PLUMB BOB INVENTED by R. PEACOCK 1968
6. PLUMB BOB PATENT from 2007



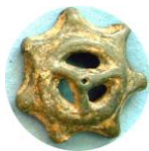

Wolf's PLUMB BOB NEWS
2009-complete
SUMMARY
of all 12 issues



Information for plumb bob collectors

Editor: Wolf Ruecker

plumbbobwolf@t-online.de

#. TITLE / CONTENTS

2009-11

page 175

LEAD AS MATERIAL FOR PLUMB BOBS (8 pp)

1. INTRODUCTION
2. WHAT IS LEAD?
3. HISTORY OF LEAD
4. THE RELATION BETWEEN THE WORD "LEAD" AND THE WORD "PLUMB" BOB
5. USE OF LEAD IN PLUMB BOBS
6. PICTURES FO LEAD PLUMB BOBS
7. CONCLUSION



2009-12

page 183

PLUMB BOB AS INCLINATION INDICATOR IN WELL HOLES (11 pp)

1. INTRODUCTION
2. PATENTS
3. US 802071 W. R. BAWDEN 1905 CLINOMETER
4. US 1738589 E. KOPPL 1929 INCLINATION INDICATOR
5. US 2139899 Frank L. BUS 1938 DEPTH MEASURING DEVICE
6. Etc.
7. CONCLUSION

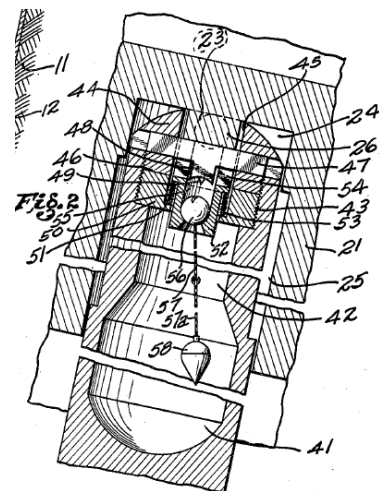

All these issues are available as single issues and complete for 2009 on
www.plumbbob.de

Also available on this website are:
the **50 articles from 2007** about PATENTED PLUMB BOBS
and the **13 articles from 2008**.

Enjoy this special information for plumb bob collectors
Wolf Ruecker
plumbbobwolf@t-online.de



Wolf's PLUMB BOB NEWS 2010-01-11 SUMMARY

Information for plumb bob collectors



Editor: Wolf Ruecker

plumbbobwolf@t-online.de

#. **TITLE / CONTENTS**

date: Dec.17, 2010

2010-01

page 8

SOLUTIONS TO ADJUST THE LINE OF A PLUMB BOB (12 pp)

1. INTRODUCTION
2. TIE A SLIDING KNOT
3. PATENTED ADJUSTERS
4. COMMON ADJUSTERS
5. INTEGRATED ADJUSTERS (REELS etc.)
6. OOF THE SUBJECT
7. CONCLUSION



2010-02

page 20

EGYPT PLUMB BOBS + SCALES WITH PLUMMET (11 pp)

1. INTRODUCTION
2. WEIGHING OF THE HEART
3. WHAT TYPES OF „SCALE-PLUMMETS“EXIST?
4. EGYPT PLUMB BOBS AND A-LEVELS
5. CONCLUSION



2010-03

page31

PLUMB BOB LINES (10 pp)

1. INTRODUCTION
2. WHY WE NEED A LINE?
3. WHAT REQUIREMENTS DO WE HAVE for a line?
4. DIFFERENT TYPES AND MATERIAL
5. WHAT INFORMATION DO WE GET FROM BOOKS?
6. HOW ARE LINES PRODUCED?
7. MY QUESTIONNAIRE 2008
8. PIANO WIRE
9. PICTURES FROM FELLOW COLLECTORS
10. CONCLUSION

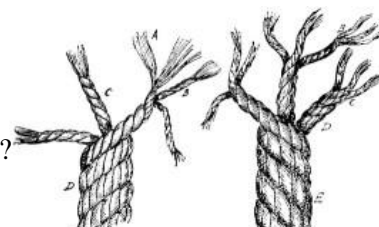



Wolf's PLUMB BOB NEWS

2010-01-11
SUMMARY

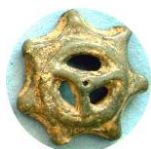

Information for plumb bob collectors

Editor: Wolf Ruecker

plumbbobwolf@t-online.de

#. TITLE / CONTENTS

2010-04

ENGLISH PLUMB BOS PART 1 (18 pp)

page 41

1. INTRODUCTION
2. WHAT IS INTERESTING IN ENGLISH PLUMB BOBS?
3. ENGLAND; MAKERS
4. COLLECTION RICHARD JONES, WALES
5. UNMARKED
6. OTHER DISTRIBUTORS
7. PATENTED PLUMB BOBS
8. LAST BUT NOT LEAST
9. RELATED PUBLICATIONS



2010-05

ENGLISH PLUMB BOS PART 2(18 pp)

page 59

1. INTRODUCTION
2. LAIRD SHIPYARD
3. PLUMB BOBS IN AUSTRALIA
4. PATENTED PLUMB BOB FROM AUSTRALIA
5. PLUMB BOBS IN NEW ZEALAND
6. PLUMB BOBS IN CANADA
7. PLUMB BOBS IN INDIA
8. CONCLUSION
9. RELATED PUBLICATIONS



2010-06

HIGHLIGHTS FROM MY READER'S COLLECTIONS (17 pp)

page 72

0. INTRODUCTION
1. YOUR OLDEST PLUMB BOB?
2. YOUR BIGGEST / HEAVIEST PLUMB BOB?
3. YOUR SMALLEST PLUMB BOB?
4. YOUR MOST BEAUTIFUL PLUMB BOB?
5. YOUR MOST UNSIGHTLY PLUMB BOB?
6. YOUR MOST UNUSUAL / EXTRAORDINARY P B?
7. YOUR "DARLING"?
8. YOUR MOST EXPENSIVE PLUMB BOB?
9. YOUR MOST INTERESTING PLUMB BOB?
10. YOUR P B WITH THE BEST STORY OR HISTORY?
11. WHICH PLUMB BOB TRAVELLED THE LONGEST DISTANCE?
12. YOUR MOST WIMSICAL PLUMB BOB?
13. YOUR RAREST PLUMB BOB?
14. YOUR VERY FIRST PLUMB BOB?
15. WHICH PLUMB BOB WOULD YOU MOST LIKE TO ADD TO YOUR COLLECTION?





Wolf's PLUMB BOB NEWS

2010-01-11
SUMMARY

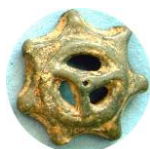

Information for plumb bob collectors

Editor: Wolf Ruecker

plumbbobwolf@t-online.de

#. TITLE / CONTENTS

2010-07

page 89

THE MOUNT RUSHMORE PLUMB BOBS (8 pp)

0. INTRODUCTION
1. MOUNT RUSHMORE + MUSEUM
2. SCULPTOR GUTZON BORGLUM
3. THE POINTING SYSTEM
4. THE PLUMB BOBS
5. REMARK
6. FOOTNOTES AND SOURCES



2010-08

page 97

SPECIAL USES OF PLUMB BOS (16 pp)

0. INTRODUCTION
1. CYCLING
2. KITE
3. GOLF
4. BOWLS
5. PINBALL
6. AEROMODELLING
7. BOMBER TRAINING
8. CARS + RAILWAYS
9. AMUSEMENT
10. ARCHERY
11. SOMETHING TO SMILE ABOUT
12. SOURCES AND FOOTNOTES

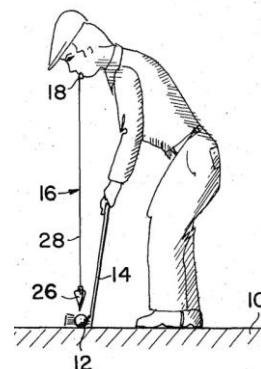

2010-09

page 113

100 YEAR ANNIVERSARY, PLUMB BOB (and CHALK LINE) PATENTS (15 pp)

0. INTRODUCTION
1. FR 406122 SCHOTT (FRANCE) 1909 THE RATIONAL P B
2. US 932218 WILSON 1909 REEL FOR PLUMB BOBS
3. US 927790 HALL 1909 CHALK LINE HOLDER
4. US 995938 AIRESMAN filed 1910 PLUMB BOB
5. US 995872 JOICE filed 1910 PLUMB BOB
6. US 971752 HULL 1910 LEVELLING AND GRADING INSTRUMENT
7. US 944654 BERGER 1909 MINING TRANSIT CENTER FINDER
8. US 916608 SCHMIDTKE 1909 PLUMB BOB
9. US 922171 LOEVEN 1909 PLUMB BOB
10. US 921302 STARR 1909 LINE CHALKER
11. US 953131 FERRIS 1910 SHAFT CENTERING DEVICE
12. US 909846 CAVILEER 1909 PLUMB BOB AND CHALK LINE HOLDER
13. US 947892 EASTMAN 1910 CHALK-LINE HOLDER
14. US 1004443 LAUT 1911 CHALK LINE HOLDER

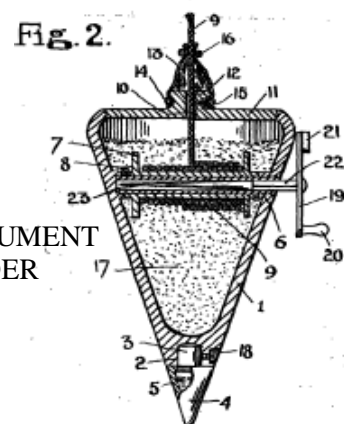



Wolf's PLUMB BOB NEWS
2010-01-11
SUMMARY

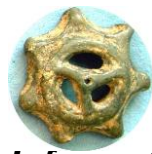

Information for plumb bob collectors

Editor: Wolf Ruecker

plumbbobwolf@t-online.de

#. TITLE / CONTENTS

2010-10

page 128

INTERNATIONAL PLUMB BOB COLLECTORS MEETING COLOGNE 2010 (16 pp)

- 0. INTRODUCTION
- 1. THE HIGH ROOF OF THE COLOGNE CATHEDRAL
- 2. PRESENTATIONS
- 3. TOOL MUSEUM Gerhard Schmitz
- 4. TUTANKAMUN EGYPTIAN EXHIBITION
- 5. ROMAN GERMAN MUSEUM
- 6. NEXT COLLECTORS MEETING 2012
- 7. REMARKS



2010-11

page 144

PLUMB BOBS IN DAMS (7 pp)

- 0. INTRODUCTION
- 1. WHY A PLUMB BOB IN A DAM?
- 2. NORMAL PLUMB LINE
- 3. INVERTED or FLOATING PLUMB LINE
- 4. HOOVER or BOLDER DAM
- 5. REMARKS



2010-12

page 151

)
(NOT YET READY)

All these issues are available as single issues and complete for 2010 on
www.plumbbobcollectors.info

Also available on this website are:
the **50 articles from 2007** about PATENTED PLUMB BOBS
and the **articles from 2008 and 2009**.

Enjoy this special information for plumb bob collectors
Wolf Ruecker plumbbobwolf@t-online.de